

NERI

Nova

Source	LED
Voltage	120-277V
Frequency	50/60Hz
EPA	0.38 sqft
Weight	17,85lb
Height	15 6/8"
Length	14 6/8"

Circular shaped lighting fixture installation on post or wall brackets, with coupling in hot galvanized steel tube (G3/4") threaded.
The Nova is ideally for illuminating urban streets, park, cycle paths or pedestrian walkways.



Compliance:
UL Standard 1598, UL8750

Project location:	
Project name:	
Model code #:	Date

Fixture type:	
Rev.	06/2024

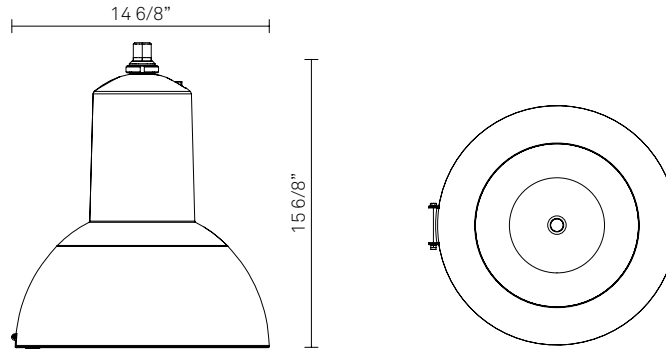

Mounting	Series	Optic system	CCT	Lumen output	Driver function	Screen
Suspended	LUNOV	Type I	2,700K	2,500	0-10V + NCL	Prismatic glass
		Type II	3,000K	3,500	Manual dimming*	
		Type III	4,000K*	4,500		
		Type IV		6,000		
		Type V		7,500		
				9,000		
				10,500		
				12,000		

SPECIFICATIONS:

Construction:

- Upper frame shaped bell in aluminum with threaded connection G 3/4".
- Lower skirt frame, hinged opening for access to the auxiliary and optical compartment.
- White internal reflector.
- Shield in flat tempered prismatic glass with impact resistance IK07.
- Osmotic valve for balanced internal/external pressure.
- Suitable for wet location.

Materials:

- Die-cast aluminum (UNI EN 1706).
- Prismatic tempered flat glass.
- Stainless steel fasteners.

Finish:

- Standard color: Neri Gray on the upper part, White matt RAL 9010 on the lower part.
- Paint system (see specific technical sheet).

Mounting:

- Suitable for suspended mounting.
- Threaded connection G 3/4".

Operation and maintenance:

- Periodic maintenance for the external cleaning of the structure and the screens from dust and smog and tightening control to the support.

TECHNICAL DATA:

Electrical:

- Voltage: 120-277V (universal).
- Rated power: from 17.8 W to 82.9 W.
- Frequency: 50/60Hz.
- Protection rating: IP66, IK07.
- Operating temp.: -31°F / +104°F.
- Electronic power supply with protection against short circuits, overheating and power surges with an estimated duration of 112,000 h.
- Automatic disconnector when opening.
- Terminal block for wires with max. section of 0.038 in².
- Input power cable with PG16 cable gland (Ø 3/8" - 4/8").
- Standard surge protection 10kV.

Optical Features:

- LED Type: Lumileds Luxeon 5050
- Source efficiency LED: 164 lm/W @ Tj=25°C, 800 mA, 3000K
- Source efficiency LED: 169 lm/W @ Tj=25°C, 800 mA, 4000K
- Lumen output: from 2,500 to 12,000 lm
- Color temperature: 2,700K or 3,000K - 4000K on request.
- Chromatic Rendering Index: > 80
- Estimated life: 100,000 hours (L90 - Tq25°C)

DRIVER FUNCTION:

Description

0-10V + NCL

(Analogic control + Neri Constant Lumen)

Manual dimming*

(Analogic control)

* On request

NERI

STANDARD | PRISMATIC GLASS
Standard version is equipped with seven lighting distribution and eight lumen output choices. Light distributions available are symmetric and asymmetric (Types: I, II, III, IV, V); lumen outputs range from 2,500lm to 12,000lm.

* On demand

Project location: _____
Project name: _____
Model code #: _____ Date: _____

Fixture type: _____
Rev. _____ 06/2024

2700K

lm tot	W tot	lm/W
2,500	18.7	134
3,500	26.6	132
4,500	35.1	128
6,000	45.8	131
7,500	58.5	128
9,000	68.6	131
10,500	80.3	131

3000K

lm tot	W tot	lm/W
2,500	17.8	140
3,500	25.4	138
4,500	33.3	135
6,000	43.8	137
7,500	55.7	135
9,000	65.1	138
10,500	76.1	138
12,000	82.9	145

4000K*

lm tot	W tot	lm/W
2,500	16.9	148
3,500	24.0	146
4,500	31.5	143
6,000	41.5	145
7,500	52.7	142
9,000	61.5	146
10,500	73.2	143
12,000	78.4	153

Type II - D
Distribution type: Asymmetric

Type III - B
Distribution type: Asymmetric

Type III - C
Distribution type: Asymmetric

Type III - H
Distribution type: Asymmetric

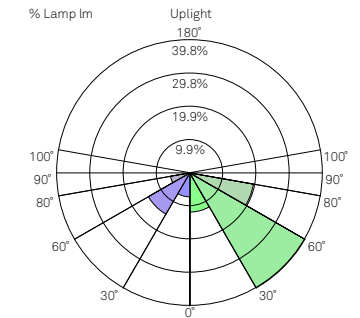
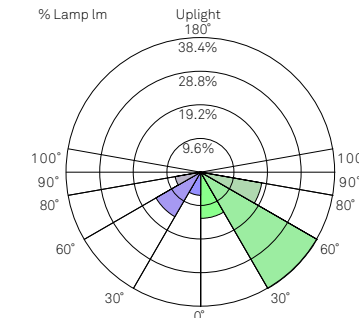
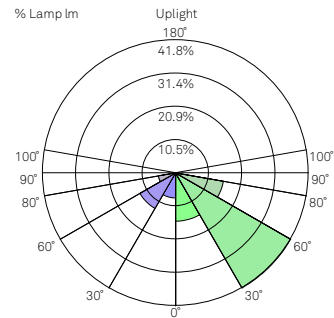
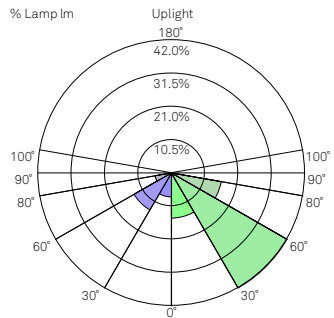
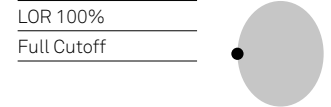
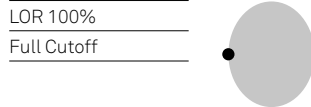
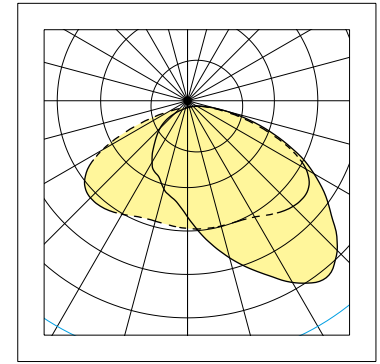
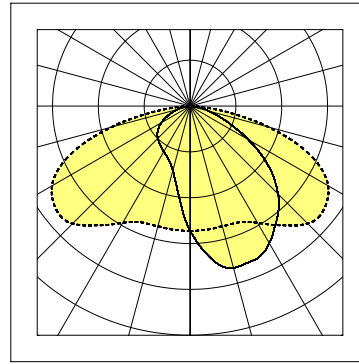
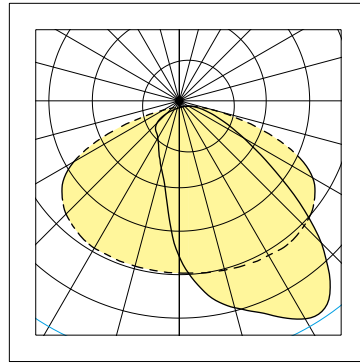
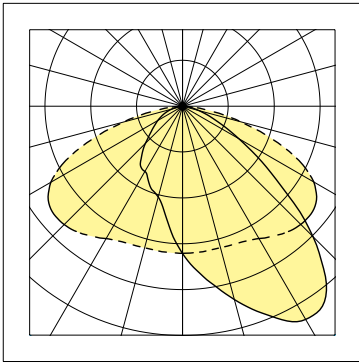

LCS Zone	Angles	% Lamp	% Lum
FL	0° - 30°	14.3	14.3
FM	30° - 60°	42.0	42.0
FH	60° - 80°	15.9	15.9
FVH	80° - 90°	1.2	1.2
BL	0° - 30°	7.6	7.6
BM	30° - 60°	13.5	13.5
BH	60° - 80°	5.2	5.2
BVH	80° - 90°	0.3	0.3
UL	90° - 100°	0.0	0.0
UH	100° - 180°	0.0	0.0
Totals		100.0	100.0

BUG (2,500lm): B1 U0 G1

LCS Zone	Angles	% Lamp	% Lum
FL	0° - 30°	15.2	15.2
FM	30° - 60°	41.8	41.8
FH	60° - 80°	15.3	15.3
FVH	80° - 90°	1.1	1.1
BL	0° - 30°	7.9	7.9
BM	30° - 60°	12.8	12.8
BH	60° - 80°	5.5	5.5
BVH	80° - 90°	0.4	0.4
UL	90° - 100°	0.0	0.0
UH	100° - 180°	0.0	0.0
Totals		100.0	100.0

BUG (2,500lm): B1 U0 G1

LCS Zone	Angles	% Lamp	% Lum
FL	0° - 30°	13.2	13.2
FM	30° - 60°	38.4	38.4
FH	60° - 80°	17.7	17.7
FVH	80° - 90°	1.4	1.4
BL	0° - 30°	6.6	6.6
BM	30° - 60°	14.7	14.7
BH	60° - 80°	7.4	7.4
BVH	80° - 90°	0.5	0.5
UL	90° - 100°	0.0	0.0
UH	100° - 180°	0.0	0.0
Totals		100.0	100.0

BUG (2,500lm): B2 U0 G2

LCS Zone	Angles	% Lamp	% Lum
FL	0° - 30°	11.7	11.7
FM	30° - 60°	39.8	39.8
FH	60° - 80°	19.4	19.4
FVH	80° - 90°	1.6	1.6
BL	0° - 30°	7.2	7.2
BM	30° - 60°	14.3	14.3
BH	60° - 80°	5.8	5.8
BVH	80° - 90°	0.4	0.4
UL	90° - 100°	0.0	0.0
UH	100° - 180°	0.0	0.0
Totals		100.0	100.0

BUG (2,500lm): B1 U0 G1

NERI

STANDARD | PRISMATIC GLASS

Standard version is equipped with seven lighting distribution and eight lumen output choices. Light distributions available are symmetric and asymmetric (Types: I, II, III, IV, V); lumen outputs range from 2,500lm to 12,000lm.

* On demand

Project location:	
Project name:	
Model code #:	Date

Fixture type:	
Rev.	06/2024

2700K

lm tot	W tot	lm/W
2,500	18.7	134
3,500	26.6	132
4,500	35.1	128
6,000	45.8	131
7,500	58.5	128
9,000	68.6	131
10,500	80.3	131

3000K

lm tot	W tot	lm/W
2,500	17.8	140
3,500	25.4	138
4,500	33.3	135
6,000	43.8	137
7,500	55.7	135
9,000	65.1	138
10,500	76.1	138
12,000	82.9	145

4000K*

lm tot	W tot	lm/W
2,500	16.9	148
3,500	24.0	146
4,500	31.5	143
6,000	41.5	145
7,500	52.7	142
9,000	61.5	146
10,500	73.2	143
12,000	78.4	153

Type I - A

Distribution type: Asymmetric

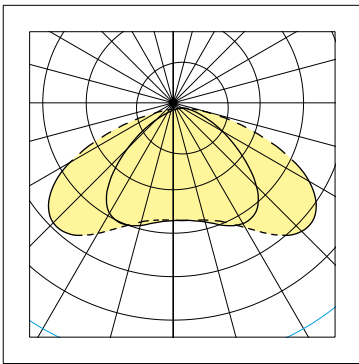

LOR 100%

Full Cutoff



Type IV - A

Distribution type: Forward throw

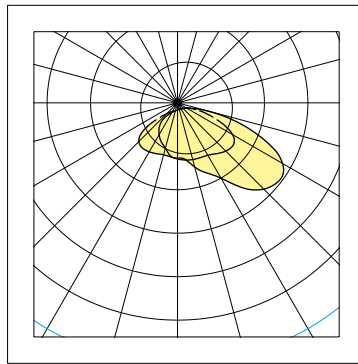

LOR 100%

Semi Cutoff

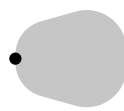

Type IV - C

Distribution type: Forward throw

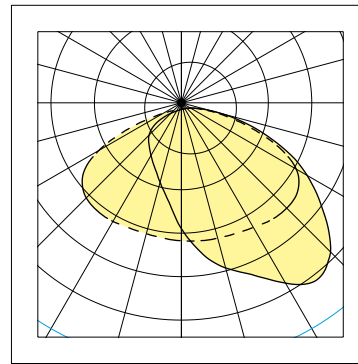

LOR 100%

Cut Off

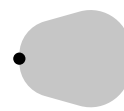

Type V - A

Distribution type: Rotosymmetric

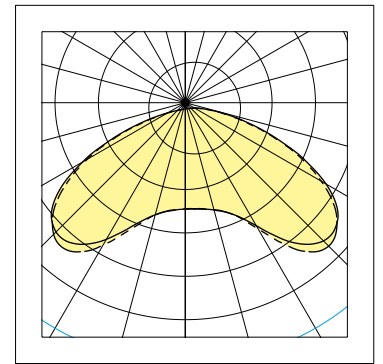

LOR 100%

Cut Off

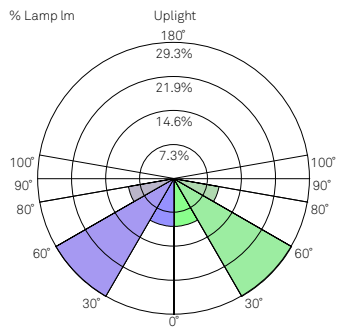

LCS Zone	Angles	% Lamp	% Lum
FL	0° - 30°	10.3	10.3
FM	30° - 60°	29.3	29.3
FH	60° - 80°	9.9	9.9
FVH	80° - 90°	0.6	0.6
BL	0° - 30°	10.3	10.3
BM	30° - 60°	29.3	29.3
BH	60° - 80°	9.9	9.9
BVH	80° - 90°	0.6	0.6
UL	90° - 100°	0.0	0.0
UH	100° - 180°	0.0	0.0
Totals		100.0	100.0

BUG (2,500lm): B1 U0 G1

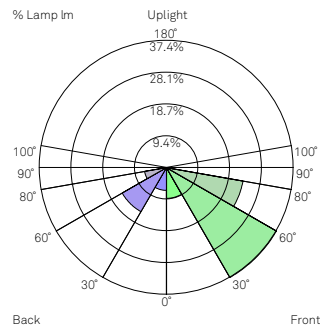

LCS Zone	Angles	% Lamp	% Lum
FL	0° - 30°	9.1	9.1
FM	30° - 60°	37.4	37.4
FH	60° - 80°	22.9	22.9
FVH	80° - 90°	2.0	2.0
BL	0° - 30°	6.7	6.7
BM	30° - 60°	15.0	15.0
BH	60° - 80°	6.5	6.5
BVH	80° - 90°	0.4	0.4
UL	90° - 100°	0.0	0.0
UH	100° - 180°	0.0	0.0
Totals		100.0	100.0

BUG (2,500lm): B1 U0 G1

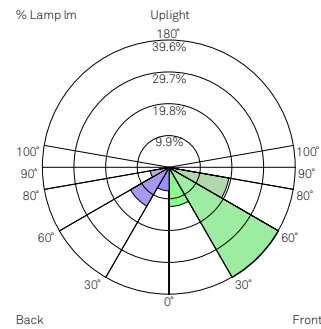

LCS Zone	Angles	% Lamp	% Lum
FL	0° - 30°	12.2	12.2
FM	30° - 60°	39.6	39.6
FH	60° - 80°	19.0	19.0
FVH	80° - 90°	1.5	1.5
BL	0° - 30°	7.3	7.3
BM	30° - 60°	13.9	13.9
BH	60° - 80°	6.0	6.0
BVH	80° - 90°	0.4	0.4
UL	90° - 100°	0.0	0.0
UH	100° - 180°	0.0	0.0
Totals		100.0	100.0

BUG (2,500lm): B1 U0 G1

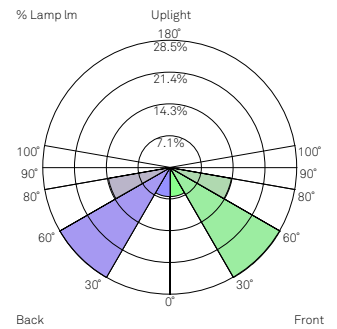

LCS Zone	Angles	% Lamp	% Lum
FL	0° - 30°	6.5	6.5
FM	30° - 60°	28.5	28.5
FH	60° - 80°	14.0	14.0
FVH	80° - 90°	0.9	0.9
BL	0° - 30°	6.5	6.5
BM	30° - 60°	28.5	28.5
BH	60° - 80°	14.0	14.0
BVH	80° - 90°	0.9	0.9
UL	90° - 100°	0.0	0.0
UH	100° - 180°	0.0	0.0
Totals		100.0	100.0

BUG (2,500lm): B1 U0 G1